



Jerry[®]medical
吉芮医疗

Product Catalog

Jerry ♡ Just for a better life!

吉芮医疗器械(上海)有限公司
Jerry Medical Instrument (Shanghai) Co., Ltd.



Jerry[®]medical
吉芮医疗

Jerry Medical
Specialize in **electric** wheelchairs

COMPANY PROFILE

Jerry medical established in 2013 is a group composed of Jerry Medical Instrument (Shanghai) Co.,Ltd, Jerry Medical Instrument (NanTong) Co.,Ltd ,Jerry Trading (Shanghai) Co.,Ltd,Jerry rehabilitation equipment Nantong Co., Ltd.Jerry medical is a specialized high-tech enterprise that integrates R&D production and sales of intelligent rehabilitation devices such as electric wheelchair mobility scooter and wheelchair etc.The company is committed to becoming a rehabilitation assistive service provider with global influence.

Jerry medical has more than 70 registered electric wheelchairs and more than 20 manual wheelchairs. It has existing inventions and practical new products patents appearance patents more than 100 type . Jerry medical has its own intellectual property system, leading technology R & D capability,efficient manufacturing process. Jerry products have been sold to more than 30 provinces and cities at domestic and more than 40 countries abroad and regions.Products have won unanimous recognition from customers, and Jerry has become a brand worthy of trust by users.

Jerry has passed the UKAS "ISO13485" medical device quality management system certification;

Jerry has passed the German TUV "CE" certification;

products have passed FDA certification;

Shanghai "high tech enterprise" accreditation enterprise;

Shanghai "specialized and special new" accreditation enterprise ;

Shanghai Jiading District "small giant enterprise" accreditation enterprise;

Shanghai "science and technology small giant cultivation enterprise" accreditation enterprise;

Shanghai Jiading District "patent work" demonstration enterprise;

News publicity sponsor of the 10th National Games for the disabled;

China Disabled Persons' Federation "Caring enterprise for the disabled" accreditation enterprise;

Guo Feng's "sunshine of love" public service song consultant enterprise;

China's cultural disabled volunteer enterprise ;

the scientific research and transformation company of the national rehabilitation aids research center;

the scientific research and transformation enterprise of University of Shanghai for Science and Technology;

the joint R & D enterprise of the China Disabled Persons' Federation project of Shantou University;

and the joint R & D unit of the China Disabled Persons' Federation project of Shanghai Xinhua Hospital.

Corporate motto: Jerry, just for a better life.

Corporate philosophy:Concentrate on work,become a leader in the electric wheelchair field

Corporate goal: to help 10 million users live a better life.

Jerry ♡ Just for a better life!



Jerry[®]medical
吉芮医疗



JERRY MEDICAL INTELLIGENT MANUFACTURING FACTORY IN NANTONG, JIANGSU

⊙ **Electric wheelchairs series**

- ⊙ JRWD3-Series
- ⊙ JRWD5-Series
- ⊙ JRWD6-Series
- ⊙ JRND7-Series
- ⊙ JRWD10-Series
- ⊙ JRWD12-Series
- ⊙ JRWD13-Series
- ⊙ JRWD16-Series
- ⊙ JRWD18-Series
- ⊙ JRWD24-Series

⊙ **Manual wheelchair series**

- ⊙ JR2-Series
- ⊙ LMW01-Series
- ⊙ LMW02-Series
- ⊙ FMW01-Series

⊙ **Mobility scooter series**

- ⊙ JRWB8-Series

⊙ **Power Patient Transfer Lift**

- ⊙ Power Patient Transfer Lift

⊙ **Jerry spare parts**

⊙ **Jerry qualification**

Jerry ♡ Just for a better life!

Jerry[®] 吉芮



◎ Foldable Backrest

Push the button, and fold the backrest easily to reduce the space.

◎ Intelligent control

Flexible, simple, accurate, full-intelligent, easy to operate.

◎ Detachable Footrest

Adjustable and detachable.comfortable and safe.

◎ Flip-up Armrest

Humanization design. Flip-up armrest, easy for users to up and down the wheelchair. Inside is filled with sponge, soft and comfortable, deduct hand pressure effectively.

◎ Chilwee Battery

Chinese battery industry leading brand.

◎ Motor

250W DC motor, stable performance.

◎ Clutch

Unique safety design. Easy to switch between manual and electric mode.

◎ Anti-tipper

Avoid wheelchair toppling over. Casters can be easily assembled and disassembled.

JRWD301U



Electric Wheelchairs Series

- Features:
- Foldable
 - Operation mode: both manual mode and electric mode
 - Removable battery box for recharging
 - Flip-up armrest, adjustable and detachable footrest
 - Controller can be exchanged from right side to the left
 - Long driving distance, up to **35KM**.





- Parameters:
- ⊙ Driving range: >20km
 - ⊙ Motor: 250W *2Pcs (Jerry)
 - ⊙ Battery: 24V 12Ah/20Ah
 - ⊙ Parking brake: **manual brake**
 - ⊙ Frame material: steel with liquid painting
 - ⊙ Frame color: ○ silver, ● blue, ● black, ● red
 - ⊙ Cushion: ● black & red, ● black & blue, ● red, ● black
 - ⊙ Max speed: 6km/h
 - ⊙ Control: Jerry

N.W. (kg)	overall length(mm)	overall width(mm)	overall height(mm)	seat width(mm)	seat depth(mm)	backrest height(mm)	seat height (mm)	folded width(mm)	front wheel(inch)	rear wheel(inch)	loading capacity(kg)
38/43	1075	685	925	450	430	390	500	420	8	22	100

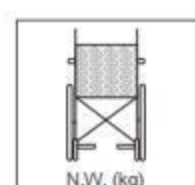

- Features:
- Foldable
 - Operation mode: both manual mode and electric mode
 - Removable battery box for recharging
 - Flip-up armrest, adjustable and detachable footrest
 - Controller can be exchanged from right side to the left
 - Long driving distance, up to **35KM**.

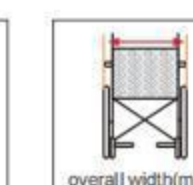
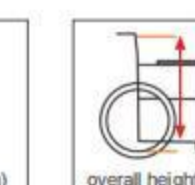
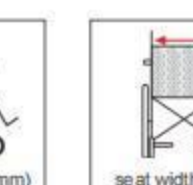
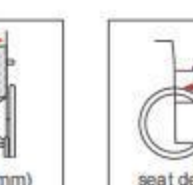
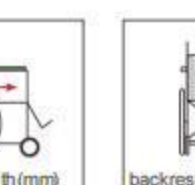
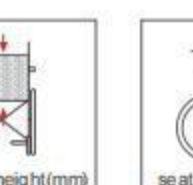
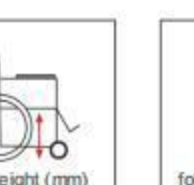
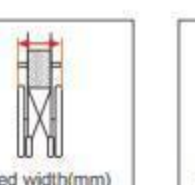
- Parameters:
- ⊙ Driving range: >20km
 - ⊙ Motor: 250W *2Pcs (Jerry)
 - ⊙ Battery: 24V 12Ah/20Ah
 - ⊙ Parking brake: **manual brake**
 - ⊙ Frame material: steel with liquid painting
 - ⊙ Frame color: ○ silver, ● blue, ● black, ● red
 - ⊙ Cushion: ● black & red, ● black & blue, ● red, ● black
 - ⊙ Max speed: 6km/h
 - ⊙ Control: Jerry

											
38/43	1075	685	925	450	430	390	500	420	8	22	100

JRWD301X



Electric Wheelchairs Series

- Features:
- Foldable
 - Operation mode: both manual mode and electric mode
 - Removable battery box for recharging
 - Flip-up armrest, adjustable and detachable footrest
 - Controller can be exchanged from right side to the left
 - Long driving distance, up to **35KM**.



- Parameters:
- ⊙ Driving range: >20km
 - ⊙ Motor: 250W *2Pcs (Jerry)
 - ⊙ Battery: 24V 12Ah/20Ah
 - ⊙ Parking brake: **manual & electromagnetic brake**
 - ⊙ Frame material: steel with liquid painting
 - ⊙ Frame color: ○silver, ●blue
 - ⊙ Cushion: ● Blue mess
 - ⊙ Max speed: 6km/h
 - ⊙ Control: Jerry

N.W. (kg)	overall length(mm)	overall width(mm)	overall height(mm)	seat width(mm)	seat depth(mm)	backrest height(mm)	seat height (mm)	folded width(mm)	front wheel(inch)	rear wheel(inch)	loading capacity(kg)
38/44	1075	685	925	450	430	390	500	465	8	22	100

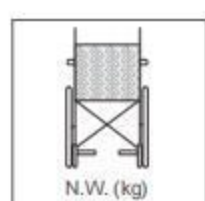
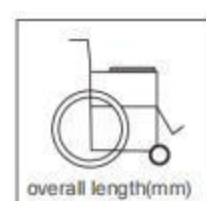
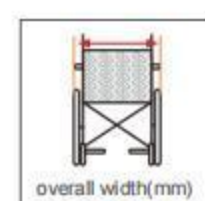
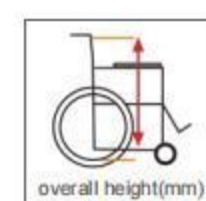
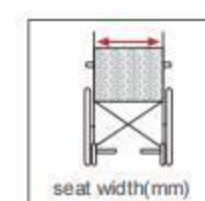
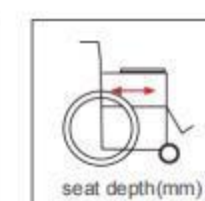
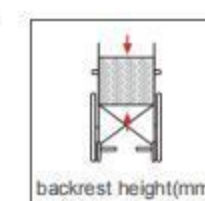
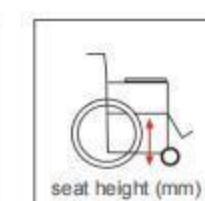
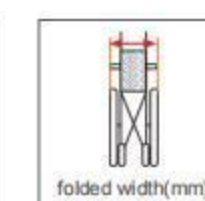
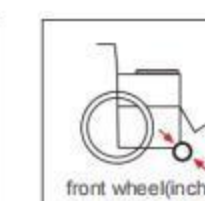

- Features: Extra function based on JRWD301
- Manual elevating footrest: adjustable angle 70°
 - Manual reclining backrest: adjustable angle 80°
 - Long driving distance, up to **35KM**.

- Parameters:
- ⊙ Driving range: >20km
 - ⊙ Moto: 250W *2Pcs (Jerry)
 - ⊙ Battery: 24V 12Ah/20Ah
 - ⊙ Parking brake: **manual brake**
 - ⊙ Frame material: steel with liquid painting
 - ⊙ Frame color: ○silver
 - Cushion: ●black
 - ⊙ Max speed: 6km/h
 - ⊙ Control: Jerry

											
43/48	1120	675	935	450	430	390	500	420	8	22	100

JRWD302X



Electric Wheelchairs Series

- Features: Extra function based on JRWD301X
- Manual elevating footrest: adjustable angle 70°
 - Manual reclining backrest: adjustable angle 80°
 - Long driving distance, up to **35KM**.









- Parameters:
- ⊙ Driving range: >20km
 - ⊙ Motor: 250W *2Pcs (Jerry)
 - ⊙ Battery: 24V 12Ah/20Ah
 - ⊙ Parking brake: **manual & electromagnetic brake**
 - ⊙ Frame material: Steel with liquid painting
 - ⊙ Frame color: ○ silver
 - ⊙ Cushion: ● black
 - ⊙ Max speed: 6km/h
 - ⊙ Control: Jerry

43/48	1120	675	935	450	430	390	500	465	8	22	100

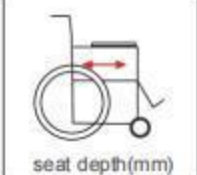
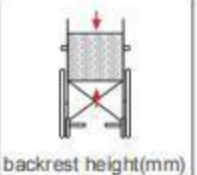
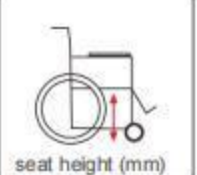
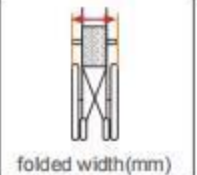

- Features: Extra function based on JRWD301
- Electric elevating footrest: adjustable angle 70°
 - Electric reclining backrest: adjustable angle 45°
 - Long driving diastance, up to **35KM**.

- Parameters:
- ☉ Driving range: >20km
 - ☉ Motor: 250W *2Pcs (Jerry)
 - ☉ Battery: 24V 12Ah/20Ah
 - ☉ Parking brake: **manual brake**
 - ☉ Frame material: steel with liquid painting
 - ☉ Frame color: ○ silver
 - ☉ Cushion: ● black
 - ☉ Max speed: 6km/h
 - ☉ Control: Jerry

											
45/50	1135	675	925	450	430	395	500	420	8	22	100

JRWD303X



Electric Wheelchairs Series

- Features: Extra function based on JRWD301X
- Electric elevating footrest: adjustable angle 70°
 - Electric reclining backrest: adjustable angle 45°
 - Long driving distance, up to **35KM**.







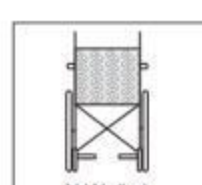

- Parameters:
- ⊙ Driving range: > 20km
 - ⊙ Motor: 250W *2Pcs (Jerry)
 - ⊙ Battery: 24V 12Ah/20Ah
 - ⊙ Parking brake: **manual & electromagnetic brake**
 - ⊙ Frame material: steel with liquid painting
 - ⊙ Frame color: ○ silver
 - ⊙ Cushion: ● black
 - ⊙ Max speed: 6km/h
 - ⊙ Control: Jerry

46/50	1105	675	925	450	430	395	500	465	8	22	100

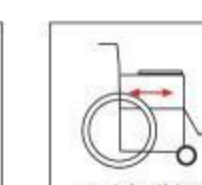
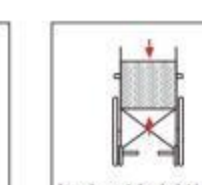
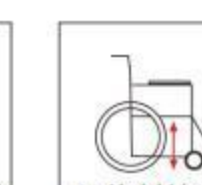
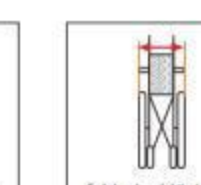

- Features:
- Foldable
 - Removable battery box for convenient recharging
 - Flip-up armrest, adjustable and detachable footrest
 - Control can be exchanged from right side to left side for both hands use

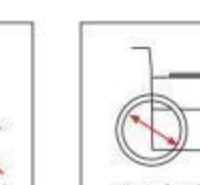
- Parameters:
- ⊙ Driving range: 15-20km
 - ⊙ Motor: 250W *2Pcs (Taiwan)
 - ⊙ Battery: 24V 20Ah/32Ah
 - ⊙ Parking brake: **electromagnetic brake**
 - ⊙ Frame material: steel with liquid painting
 - ⊙ Frame color: ○ silver
 - ⊙ Cushion: ● Blue mess
 - ⊙ Max speed: 6km/h
 - ⊙ Control: Jerry/PG/Dynamic

											
46	1150	630	940	450	435	400	505	330	8	12	100

JRWD502G



Electric Wheelchairs Series

- Features:
- Extra function based on JRWD501
 - Manual elevating footrest: adjustable angle 60°
 - Manual reclining backrest: adjustable angle 80°



- Parameters:
- ⊙ Driving range: 15-20km
 - ⊙ Motor: 250W *2Pcs(Taiwan)
 - ⊙ Battery: 24V 20Ah/32Ah
 - ⊙ Parking brake: **electromagnetic brake**
 - ⊙ Frame material: steel with liquid painting
 - ⊙ Frame color: ○ silver
 - ⊙ Cushion: ● black
 - ⊙ Max speed: 6km/h
 - ⊙ Control: Jerry/PG/Dynamic

51	1205	630	940	450	430	395	505	330	8	12	100

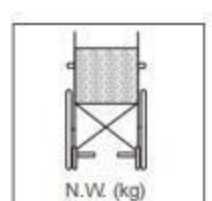
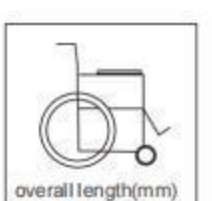
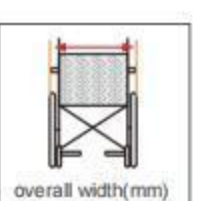
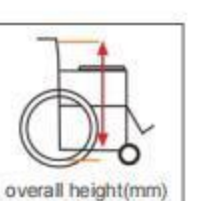
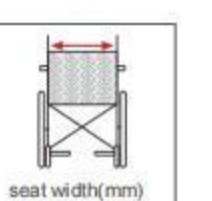
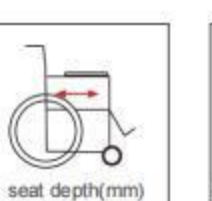
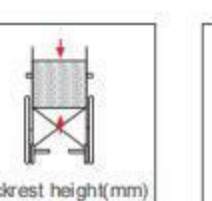
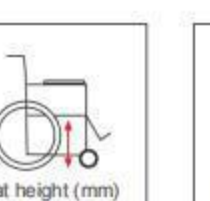
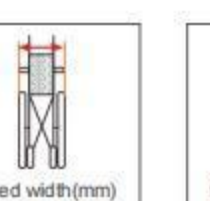
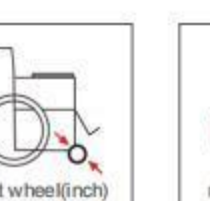
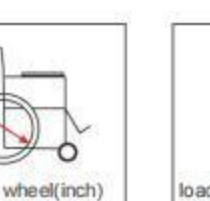

- Features:
- Extra function based on JRWD501
 - Electric elevating footrest: adjustable angle 70°
 - Electric reclining backrest: adjustable angle 45°

- Parameters:
- ⊙ Driving range: 15-20km
 - ⊙ Motor: 250W *2Pcs(Taiwan)
 - ⊙ Battery: 24V 20Ah/32Ah
 - ⊙ Parking brake: **electromagnetic brake**
 - ⊙ Frame material: steel with liquid painting
 - ⊙ Frame color: ○ silver
 - ⊙ Cushion: ● black
 - ⊙ Max speed: 6km/h
 - ⊙ Control: Jerry/PG/Dynamic

											
53	1185	630	940	450	430	390	505	330	8	12	100

JRWD601G



Electric Wheelchairs Series

- Features:
- Unique shock absorption design
 - Backrest angle is adjustable
 - Height adjustable armrest, adjustable and detachable footrest
 - Control can be exchanged from right side to left side for both hands use







- Parameters:
- ⊙ Driving range: 15-20km
 - ⊙ Motor: 250W *2Pcs (Taiwan)
 - ⊙ Battery: 24V 20Ah/32Ah
 - ⊙ Parking brake: **electromagnetic brake**
 - ⊙ Frame material: steel with liquid painting
 - ⊙ Frame color: ●red
 - ⊙ Cushion: ●black
 - ⊙ Max speed: 6km/h
 - ⊙ Control: Jerry/PG/Dynamic

63	1030	590	1070	450	450	480	495	N/A	8	12	100

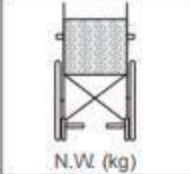
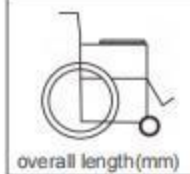
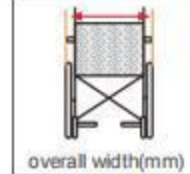

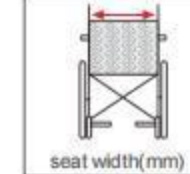
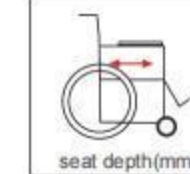
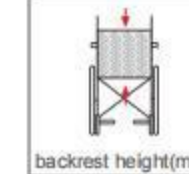
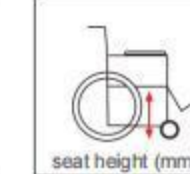
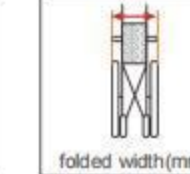
- Features:
- Unique shock absorption design
 - Backrest angle is adjustable
 - Height adjustable armrest, adjustable and detachable footrest
 - Control can be exchanged from right side to left side for both hands use

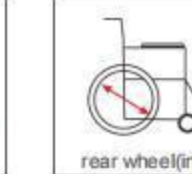
- Parameters:
- ⊙ Driving range: 15-20km
 - ⊙ Motor: 250W *2Pcs (Taiwan)
 - ⊙ Battery: 24V 20Ah/32Ah
 - ⊙ Parking brake: **electromagnetic brake**
 - ⊙ Frame material: steel with liquid painting
 - ⊙ Frame color: ●red
 - ⊙ Cushion: ●black
 - ⊙ Max speed: 6km/h
 - ⊙ Control: Jerry/PG/Dynamic

											
74	1000	610	1400	450	380	570	600	N/A	8	12	100

JRWD6010X



Electric Wheelchairs Series

- Features:
- Two-step quick folding
 - Removable battery box for recharging
 - Comfortable contoured cushion, gel in sacrum area
 - Controller can be exchanged from right side to the left
 - Long driving diastance, up to **25KM**.







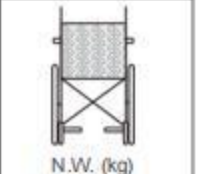

- Parameters:
- ⊙ Driving range: >20km
 - ⊙ Motor: 250W *2Pcs (Jerry)
 - ⊙ Battery: 24V 12Ah/20Ah (Lithium battery)
 - ⊙ Parking brake: **electromagnetic brake**
 - ⊙ Frame material: aluminium alloy
 - ⊙ Frame color: ○white
 - ⊙ Cushion: ●black
 - ⊙ Max speed: 6km/h
 - ⊙ Control: Jerry

26/27	980	610	945	440	400	430	460	390	8	10	100

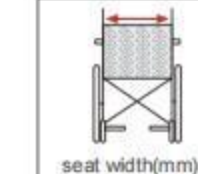

- Features:
- Automatic folding
 - Removable battery box for recharging
 - Comfortable contoured cushion, gel in sacrum area
 - Controller can be exchanged from right side to the left
 - Backrest:Manual reclining
 - Long driving diastance, up to **25KM**.

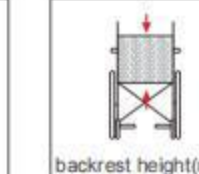
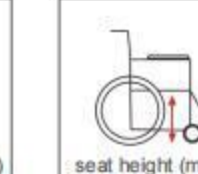
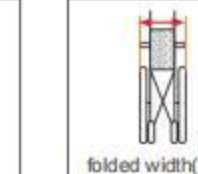
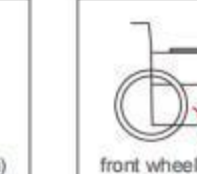
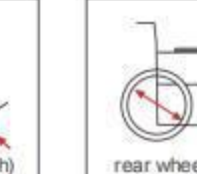
- Parameters:
- ⊙ Driving range: >20km
 - ⊙ Max speed: 6km/h
 - ⊙ Motor: 250W *2Pcs (Jerry)
 - ⊙ Control: Jerry
 - ⊙ Battery: 24V 12Ah/20Ah (Lithium battery)
 - ⊙ Parking brake: **electromagnetic brake**
 - ⊙ Frame material: aluminium alloy
 - ⊙ Frame color: ●black
 - ⊙ Cushion: ●black

											
N.W. (kg)	overall length(mm)	overall width(mm)	overall height(mm)	seat width(mm)	seat depth(mm)	backrest height(mm)	seat height (mm)	folded width(mm)	front wheel(inch)	rear wheel(inch)	loading capacity(kg)
27/28	980	610	945	440	400	430	460	390	8	10	100

JRWD6012X



Electric Wheelchairs Series

- Features:
- Foldable directly
 - Removable battery box for recharging
 - Controller can be exchanged from right side to the left
 - Long driving distance, up to **25KM**.







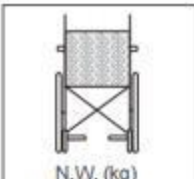

- Parameters:
- ⊙ Driving range: >20km
 - ⊙ Motor: 250W *2Pcs (Jerry)
 - ⊙ Battery: 24V 12Ah/20Ah(Lithium battery)
 - ⊙ Parking brake: **electromagnetic brake**
 - ⊙ Frame material: aluminium alloy
 - ⊙ Frame color: ○ silver
 - ⊙ Cushion color: ● black
 - ⊙ Max speed: 6km/h
 - ⊙ Control: Jerry

26/27	990	610	945	445	400	430	460	425	8	12	100

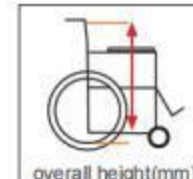
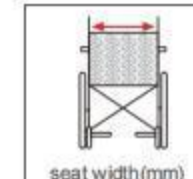

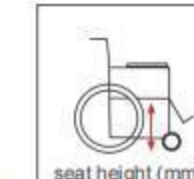
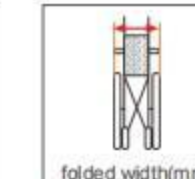
- Features:
- Foldable directly
 - Removable battery box for recharging
 - Controller can be exchanged from right side to the left
 - Backrest:Manual reclining
 - Long driving diastance, up to **25KM**.

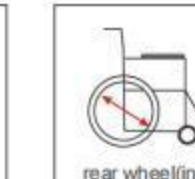
- Parameters:
- ⊙ Driving range: > 20km
 - ⊙ Motor: 250W *2Pcs (Jerry)
 - ⊙ Battery: 24V 12Ah/20Ah(Lithium battery)
 - ⊙ Parking brake: **electromagnetic brake**
 - ⊙ Frame material: aluminium alloy
 - ⊙ Frame color: ○silver
 - ⊙ Cushion color: ●black
 - ⊙ Max speed: 6km/h
 - ⊙ Control: Jerry
 - ⊙ Adjustable backrest: 50°

											
28/29	940	605	945	445	400	430	460	425	8	12	100

JRWD6012X.B



Electric Wheelchairs Series

- Features:
- Automatic folding
 - Removable battery box for recharging
 - Comfortable contoured cushion, gel in sacrum area
 - Controller can be exchanged from right side to the left
 - Backrest:electric reclining
 - Long driving diastance, up to **25KM**.
- Option: bottom bag,headre







- Parameters:
- ⊙ Driving range: >20km
 - ⊙ Motor: 250W *2Pcs (Jerry)
 - ⊙ Battery: 24V 12Ah/20Ah (Lithium battery)
 - ⊙ Parking brake: **electromagnetic brake**
 - ⊙ Frame material: aluminium alloy
 - ⊙ Frame color: ●black
 - ⊙ Cushion: ●black
 - ⊙ Max speed: 6km/h
 - ⊙ Control: Jerry

N.W. (kg)	overall length (mm)	overall width (mm)	overall height (mm)	seat width (mm)	seat depth (mm)	backrest height (mm)	seat height (mm)	folded width (mm)	front wheel (inch)	rear wheel (inch)	loading capacity (kg)
27/28	980	610	945	440	400	430	460	390	8	12	100

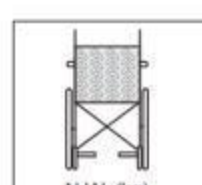

- Features:
- Foldable directly
 - Removable battery box for recharging
 - Controller can be exchanged from right side to the left
 - Long driving diastance, up to **25KM**.

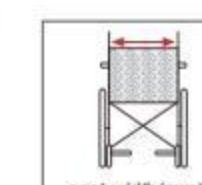
- Parameters:
- ⊙ Driving range: >20km
 - ⊙ Motor: 250W *2Pcs (Jerry)
 - ⊙ Battery: 24V 12Ah/20Ah(Lithium battery)
 - ⊙ Parking brake: **electromagnetic brake**
 - ⊙ Frame material: aluminium alloy
 - ⊙ Frame color: ●black
 - ⊙ Cushion color: ●black
 - ⊙ Max speed: 6km/h
 - ⊙ Control: Jerry

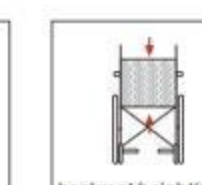
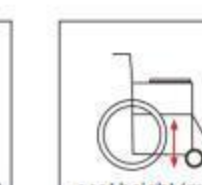
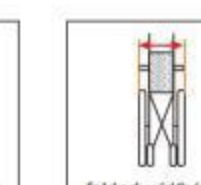
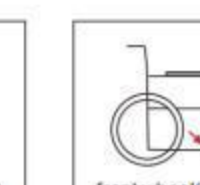
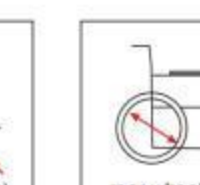
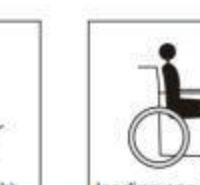
											
26/27	990	610	945	445	400	430	460	425	8	12	100

JRND701G



Electric Wheelchairs Series

- Features:
- Foldable
 - Removable battery box for convenient recharging
 - Flip-up armrest, adjustable and detachable footrest
 - Control can be exchanged from right side to left side for both hands use



- Parameters:
- ⊙ Driving range: 15-20km
 - ⊙ Motor: 250W *2Pcs (Taiwan)
 - ⊙ Battery: 24V 20Ah/32Ah
 - ⊙ Parking brake: **electromagnetic brake**
 - ⊙ Frame material: aluminium alloy
 - ⊙ Frame color: ● silver, ● blue & black
 - ⊙ Cushion color: ● Blue mess
 - ⊙ Max speed: 6km/h
 - ⊙ Control: Jerry/PG/Dynamic

41	1060	610	945	450	430	400	505	320	8	12	100

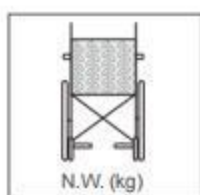
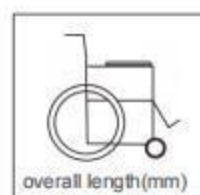
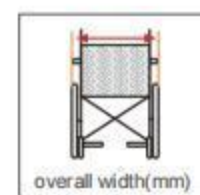
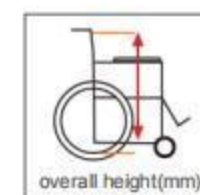
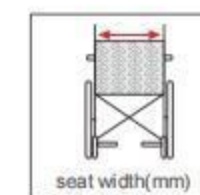
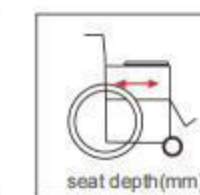
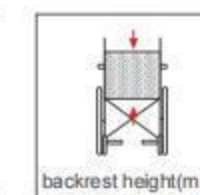
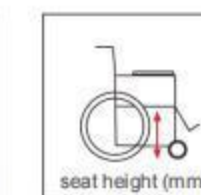
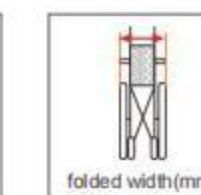
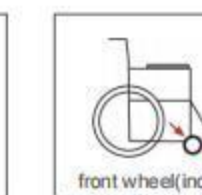
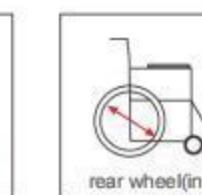

- Features:
- Foldable
 - Removable battery box for recharging
 - Flip-up armrest, adjustable and detachable footrest
 - Controller can be exchanged from right side to the left
 - Long driving distance, up to **25KM**.

- Parameters:
- ⊙ Driving range: >20km
 - ⊙ Motor: 200W *2Pcs (Jerry)
 - ⊙ Battery: 24V 12Ah/20Ah
 - ⊙ Parking brake: **manual brake**
 - ⊙ Frame material: steel with liquid painting
 - ⊙ Frame color: ○silver, ●blue, ●black, ●red
 - ⊙ Cushion: ●black & red, ●black & blue, ●red, ●black
 - ⊙ Max speed: 6km/h
 - ⊙ Control: Jerry

											
N.W. (kg)	overall length (mm)	overall width (mm)	overall height (mm)	seat width (mm)	seat depth (mm)	backrest height (mm)	seat height (mm)	folded width (mm)	front wheel (inch)	rear wheel (inch)	loading capacity (kg)
37/41	1080	650	930	450	435	400	505	370	8	12	100

JRWD1002U.B



Electric Wheelchairs Series

- Features:
- Foldable
 - Removable battery box for recharging
 - Flip-up armrest, adjustable and detachable footrest
 - Controller can be exchanged from right side to the left
 - Long driving distance, up to **25KM**.





- Parameters:
- ⊙ Driving range: >20km
 - ⊙ Motor: 250W *2Pcs (Jerry)
 - ⊙ Battery: 24V 12Ah/20Ah
 - ⊙ Parking brake: **manual brake**
 - ⊙ Frame material: steel with liquid painting
 - ⊙ Frame color: ○silver, ●blue, ●black, ●red
 - ⊙ Cushion: ●black & red, ●black & blue, ●red, ●black
 - ⊙ Max speed: 6km/h
 - ⊙ Control: Jerry

37/41	1080	650	930	450	435	400	505	370	8	12	100

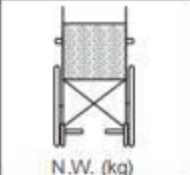
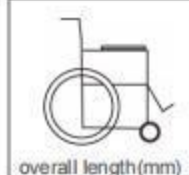

- Features:
- Standing electric wheelchair
 - Electric elevating footrest: adjustable angle 80°
 - Electric reclining backrest: adjustable angle 60°

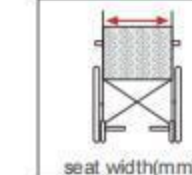
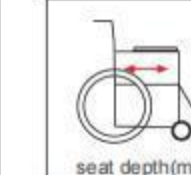
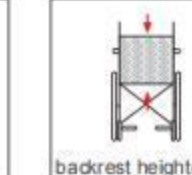
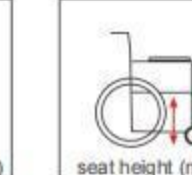
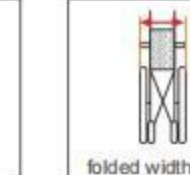
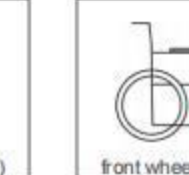
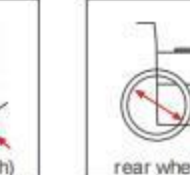
- Parameters:
- ⊙ Driving range: 20-30km
 - ⊙ Motor: 250W *2Pcs (Taiwan)
 - ⊙ Battery: 24V 32Ah
 - ⊙ Parking brake: **electromagnetic brake**
 - ⊙ Frame material: steel with liquid painting
 - ⊙ Frame color: ●black
 - ⊙ Cushion: ●black
 - ⊙ Max speed: 6km/h
 - ⊙ Control: Dynamic

											
102	1110	620	1290	450	490	640	500	N/A	12	8	100

JRWD1201X



Electric Wheelchairs Series

- Features:
- Foldable
 - Removable battery box for recharging
 - Flip-up armrest, adjustable and detachable footrest
 - Controller can be exchanged from right side to the left
 - Long driving distance, up to **25KM**.





- Parameters:
- ⊙ Driving range: > 20km
 - ⊙ Motor: 250W *2Pcs (Jerry)
 - ⊙ Battery: 24V 12Ah/20Ah
 - ⊙ Parking brake: **electromagnetic brake**
 - ⊙ Frame material: steel with liquid painting
 - ⊙ Frame color: ○ silver
 - ⊙ Cushion: ● Blue mess
 - ⊙ Max speed: 6km/h
 - ⊙ Control: Jerry

42/47	1140	640	935	450	435	395	500	470	8	12	100

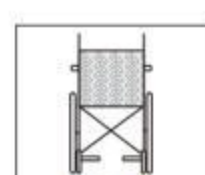
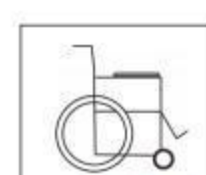
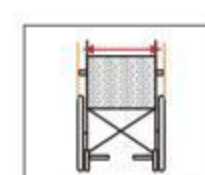
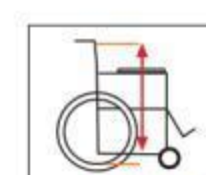
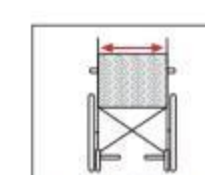
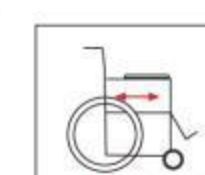
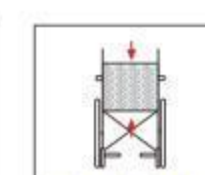
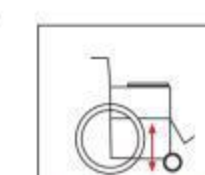

- Features:
- Foldable
 - Removable battery box for recharging
 - Flip-up armrest, adjustable and detachable footrest
 - Controller can be exchanged from right side to the left
 - Long driving distance, up to **25KM**.

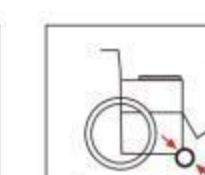
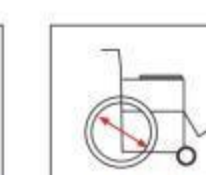
- Parameters:
- ⊙ Driving range: >20km
 - ⊙ Motor: 250W *2Pcs (Jerry)
 - ⊙ Battery: 24V 12Ah/20Ah
 - ⊙ Parking brake: **electromagnetic brake**
 - ⊙ Frame material: steel with liquid painting
 - ⊙ Frame color: ○ silver
 - ⊙ Cushion: ● Blue mess
 - ⊙ Max speed: 6km/h
 - ⊙ Control: Jerry

											
42/47	1140	640	935	450	435	395	500	470	8	12	100

JRWD1203X



Electric Wheelchairs Series

- Features:
- Foldable
 - Flip-up armrest, detachable footrest
 - Controller can be exchanged from right side to left
 - Extra function based on JRWD1201X
 - Electric elevating footrest: adjustable angle 70°
 - Electric elevating backrest: adjustable angle 45°
 - Long driving distance: up to 20 km





- Parameters:
- ⊙ Driving range: >20km
 - ⊙ Max speed: 6km/h
 - ⊙ Motor: 250W *2Pcs (Jerry)
 - ⊙ Control: Jerry
 - ⊙ Battery: 24V 12Ah/20Ah
 - ⊙ Parking brake: **electromagnetic brake**
 - ⊙ Frame material: steel with liquid painting
 - ⊙ Frame color: ○silver, ●black
 - ⊙ Cushion: ●black

58	1235	635	930	450	430	405	500	480	8	12	100

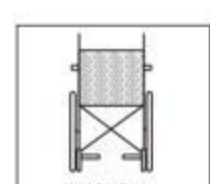
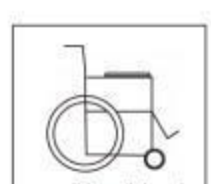
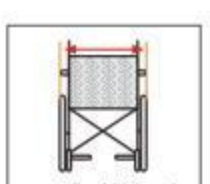
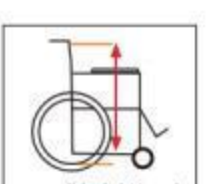
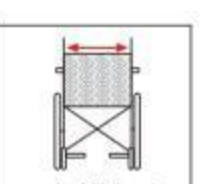
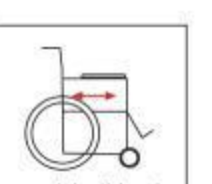
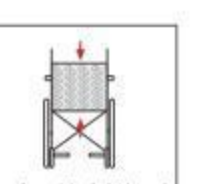
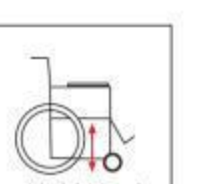
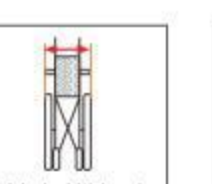

- Features:
- Unique shock absorption design.
 - Removable battery box for recharging.
 - Flip-up armrest, detachable footrest.
 - Controller can be exchanged from right side to left.
 - Long driving distance, up to **25KM**.

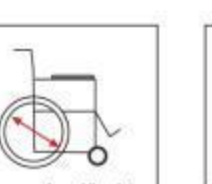
- Parameters:
- ⊙ Driving range: >20km
 - ⊙ Motor: 250W *2Pcs (Jerry)
 - ⊙ Battery: 24V 12Ah/20Ah
 - ⊙ Parking brake: **electromagnetic brake**
 - ⊙ Frame material: aluminium alloy
 - ⊙ Frame color: ● red & black
 - ⊙ Cushion color: ● black mess
 - ⊙ Max speed: 6km/h
 - ⊙ Control: Jerry

											
N.V. (kg)	overall length (mm)	overall width (mm)	overall height (mm)	seat width (mm)	seat depth (mm)	backrest height (mm)	seat height (mm)	folded width (mm)	front wheel (inch)	rear wheel (inch)	loading capacity (kg)
32/37	1005	635	965	450	430	400	510	465	8	12	100

JRWD1201LX-ER



Electric Wheelchairs Series

- Features:
- Quick folding
 - Flip-up armrest, detachable footrest
 - Controller can be exchanged from right side to left
 - Long driving distance: up to 25 km







- Parameters:
- ⊙ Driving range: >20km
 - ⊙ Max speed: 6km/h
 - ⊙ Motor: 250W *2Pcs (Jerry)
 - ⊙ Control: Jerry
 - ⊙ Battery: 24V 6Ah/12Ah(Lithium battery)
 - ⊙ Parking brake: **electromagnetic brake**
 - ⊙ Frame material: aluminium alloy
 - ⊙ Frame color: ○white, ●red, ●red& black
 - ⊙ Cushion color: ●carton

22/28	730	540	960	350	395	405	510	450	8	12	100

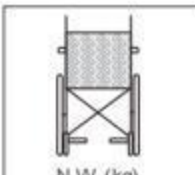

- Features:
- Quick folding
 - Flip-up armrest, detachable footrest
 - Controller can be exchanged from right side to left
 - Long driving distance: up to 20 km

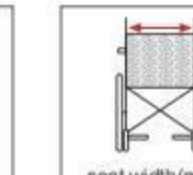
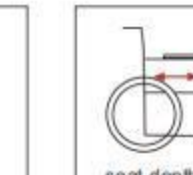
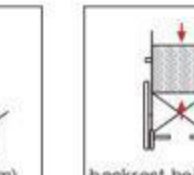
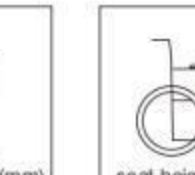
- Parameters:
- ⊙ Driving range: > 20km
 - ⊙ Max speed: 6km/h
 - ⊙ Motor: 150W *2 PC brushless
 - ⊙ Control: Mini brushless
 - ⊙ Battery: 24v 6/12AH (Lithium battery)
 - ⊙ Parking brake: **electromagnetic brake**
 - ⊙ Frame material: aluminium alloy
 - ⊙ Frame color: ● silver
 - ⊙ Cushion color: ● Black

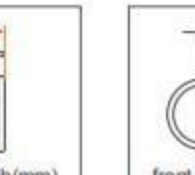
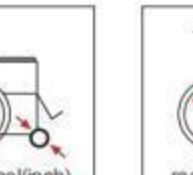
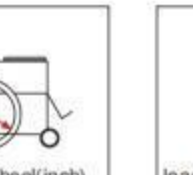
											
18/20	1010	585	900	440	400	410	475	310	7	12	100

JRWD1601U



Electric Wheelchairs Series

- Features:
- Foldable
 - Removable battery box for recharging
 - Flip-up armrest, adjustable and detachable footrest
 - Controller can be exchanged from right side to the left
 - Long driving distance, up to **30KM**.







- Parameters:
- ⊙ Driving range: >20km
 - ⊙ Motor: 250W *2Pcs (Jerry)
 - ⊙ Battery: 24V 12Ah/20Ah
 - ⊙ Parking brake: **manual brake**
 - ⊙ Frame material: steel with liquid painting
 - ⊙ Frame color: ○ silver, ● blue, ● black
 - ⊙ Cushion: ● black
 - ⊙ Max speed: 6km/h
 - ⊙ Control: Jerry

N.W. (kg)	overall length(mm)	overall width(mm)	overall height(mm)	seat width(mm)	seat depth(mm)	backrest height(mm)	seat height (mm)	folded width(mm)	front wheel(inch)	rear wheel(inch)	loading capacity(kg)
42/47	1135	635	960	450	430	400	530	370	10	16	100

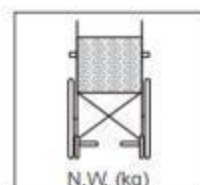
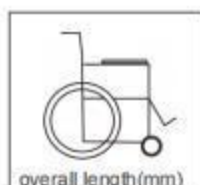

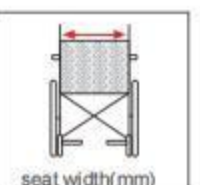
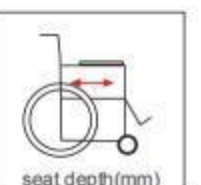
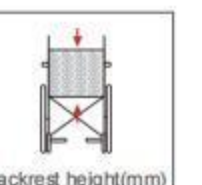
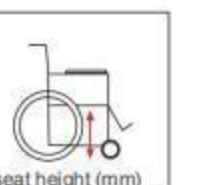
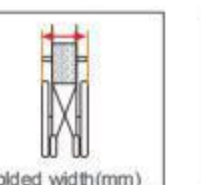
- Features:
- Foldable
 - Removable battery box for recharging
 - Flip-up armrest, adjustable and detachable footrest
 - Controller can be exchanged from right side to the left
 - Long driving diastance, up to **30KM**.

- Parameters:
- ⊙ Driving range: >20km
 - ⊙ Motor: 250W *2Pcs (Jerry)
 - ⊙ Battery: 24V 12Ah/20Ah
 - ⊙ Parking brake: **manual & electromagnetic brake**
 - ⊙ Frame material: steel with liquid painting
 - ⊙ Frame color: ○ silver, ● blue, ● black
 - ⊙ Cushion: ● Blue mess
 - ⊙ Max speed: 6km/h
 - ⊙ Control: Jerry

											
43/48	1135	635	960	450	430	400	530	425	10	16	100



JRWD1602U



Electric Wheelchairs Series

- Features: Extra function based on JRWD1601
- Manual elevating footrest: adjustable angle 70°
 - Manual reclining backrest: adjustable angle 80°
 - Long driving diastance, up to **30KM**.

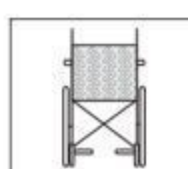
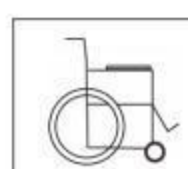
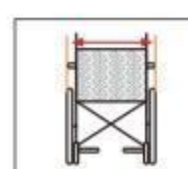
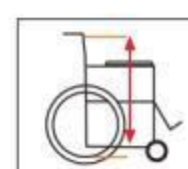
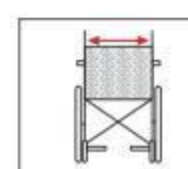
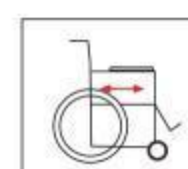
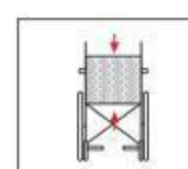
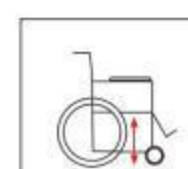
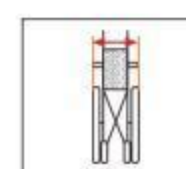
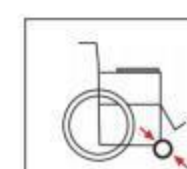
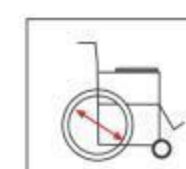

- Parameters:
- ⊙ Driving range: >20km
 - ⊙ Motor: 250W *2Pcs (Jerry)
 - ⊙ Battery: 24V 12Ah/20Ah
 - ⊙ Parking brake: **manual brake**
 - ⊙ Frame material: steel with liquid painting
 - ⊙ Frame color: ○ silver
 - ⊙ Cushion: ● black
 - ⊙ Max speed: 6km/h
 - ⊙ Control: Jerry

											
47/51	1125	635	970	450	430	390	530	370	10	16	100

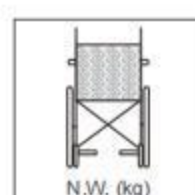

- Features: Extra function based on JRWD1601X
- Manual elevating footrest: adjustable angle 70°
 - Manual reclining backrest: adjustable angle 80°
 - Long driving distance, up to **30KM**.

- Parameters:
- ⊙ Driving range: >20km
 - ⊙ Motor: 250W *2Pcs (Jerry)
 - ⊙ Battery: 24V 12Ah/20Ah
 - ⊙ Parking brake: **manual & electromagnetic brake**
 - ⊙ Frame material: steel with liquid painting
 - ⊙ Frame color: ○ silver
 - ⊙ Cushion: ● black
 - ⊙ Max speed: 6km/h
 - ⊙ Control: Jerry

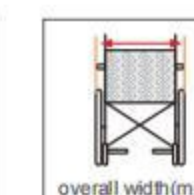
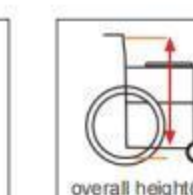
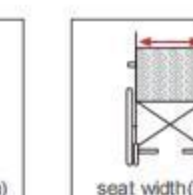
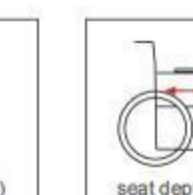
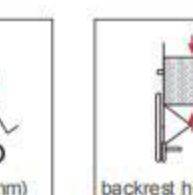
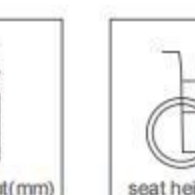
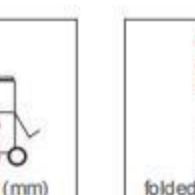
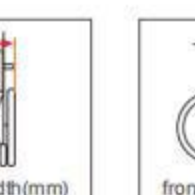
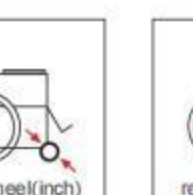
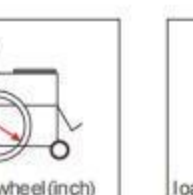
											
N.W. (kg)	overall length(mm)	overall width(mm)	overall height(mm)	seat width(mm)	seat depth(mm)	backrest height(mm)	seat height (mm)	folded width(mm)	front wheel(inch)	rear wheel(inch)	loading capacity(kg)
48/52	1120	635	970	450	430	400	535	425	10	16	100

JRWD1603U



Electric Wheelchairs Series

- Features: Extra function based on JRWD1601
- Electric elevating footrest: adjustable angle 70°
 - Electric reclining backrest: adjustable angle 45°
 - Long driving diastance, up to **30KM**.



- Parameters:
- ⊙ Driving range: >20km
 - ⊙ Motor: 250W *2Pcs (Jerry)
 - ⊙ Battery: 24V 12Ah/20Ah
 - ⊙ Parking brake: **manual & electromagnetic brake**
 - ⊙ Frame material: Steel with liquid painting
 - ⊙ Frame color: ○ silver
 - ⊙ Cushion: ● black
 - ⊙ Max speed: 6km/h
 - ⊙ Control: Jerry

50/55	1110	635	960	450	430	395	510	375	10	16	100

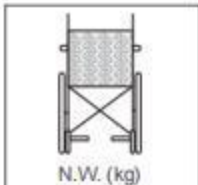
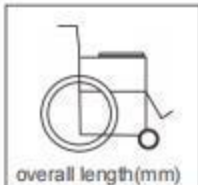
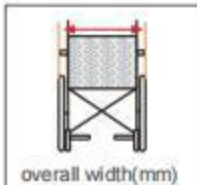
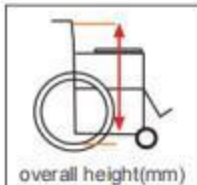
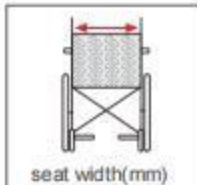
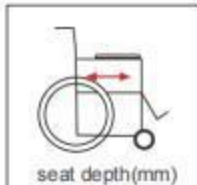
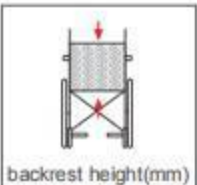
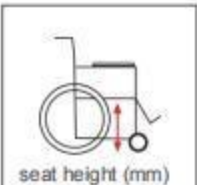
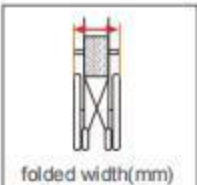
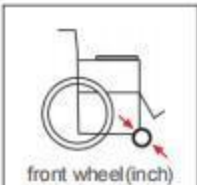

- Features: Extra function based on JRWD1601X
- Electric elevating footrest: adjustable angle 70°
 - Electric reclining backrest: adjustable angle 45°
 - Long driving diastance, up to **30KM**.

- Parameters:
- ⊙ Driving range: > 20km
 - ⊙ Motor: 250W *2Pcs (Jerry)
 - ⊙ Battery: 24V 12Ah/20Ah
 - ⊙ Parking brake: **manual & electromagnetic brake**
 - ⊙ Frame material: Steel with liquid painting
 - ⊙ Frame color: ○ silver
 - ⊙ Cushion: ● black
 - ⊙ Max speed: 6km/h
 - ⊙ Control: Jerry

											
51/56	1110	635	960	450	430	395	510	375	10	16	100

JRWD1801U



Electric Wheelchairs Series

- Features:
- Foldable
 - Removable battery box for recharging
 - Flip-up armrest, adjustable and detachable footrest
 - Controller can be exchanged from right side to the left
 - Long driving distance, up to **30KM**.









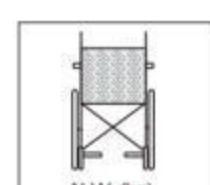

- Parameters:
- ⊙ Driving range: >20km
 - ⊙ Max speed: 6km/h
 - ⊙ Motor: 250W *2Pcs (Jerry)
 - ⊙ Control: Jerry
 - ⊙ Battery: 24V 12Ah/20Ah
 - ⊙ Parking brake: **manual brake**
 - ⊙ Frame material: steel with liquid painting
 - ⊙ Frame color: ○ silver, ● blue, ● black
 - ⊙ Cushion: ● black & red

42/47	1135	635	960	450	430	400	530	370	10	18	100

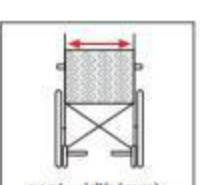
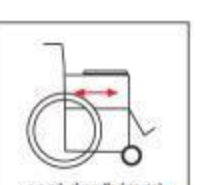
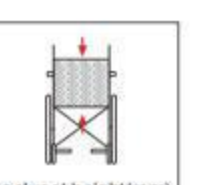

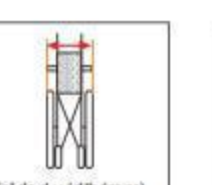
- Features:
- Foldable
 - Removable battery box for recharging
 - Flip-up armrest, adjustable and detachable footrest
 - Controller can be exchanged from right side to the left
 - Long driving diastance, up to **30KM**.

- Parameters:
- ⊙ Driving range: > 20km
 - ⊙ Motor: 250W *2Pcs (Jerry)
 - ⊙ Battery: 24V 12Ah/20Ah
 - ⊙ Parking brake: **manual & electromagnetic brake**
 - ⊙ Frame material: steel with liquid painting
 - ⊙ Frame color: ○ silver, ● blue, ● black
 - ⊙ Cushion: ● Blue mess
 - ⊙ Max speed: 6km/h
 - ⊙ Control: Jerry

											
43/48	1135	635	960	450	430	400	530	425	10	18	100

JRWD1801LU



Electric Wheelchairs Series

- Features:
- Foldable
 - Removable battery box for recharging
 - Flip-up armrest, adjustable and detachable footrest
 - Controller can be exchanged from right side to the left
 - Long driving distance, up to **30KM**.







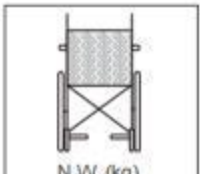

- Parameters:
- ⊙ Driving range: >20km
 - ⊙ Motor: 250W *2Pcs (Jerry)
 - ⊙ Battery: 24V 12Ah/20Ah
 - ⊙ Parking brake: **manual brake**
 - ⊙ Frame material: Aluminium alloy
 - ⊙ Frame color: ○ silver, ● blue, ● black
 - ⊙ Cushion: ● Blue mess
 - ⊙ Max speed: 6km/h
 - ⊙ Control: Jerry

34/38	1030	615	955	450	435	400	510	435	8	16	100

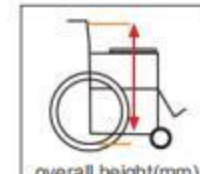
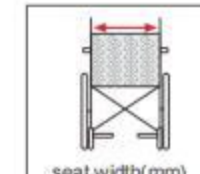
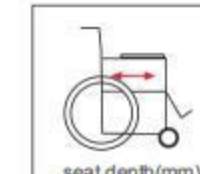
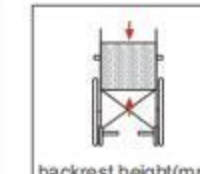

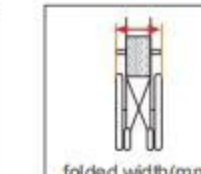
- Features:
- Foldable
 - Removable battery box for recharging
 - Flip-up armrest, adjustable and detachable footrest
 - Controller can be exchanged from right side to the left
 - Long driving diastance, up to **30KM**.

- Parameters:
- ⊙ Driving range: >20km
 - ⊙ Motor: 250W *2Pcs (Jerry)
 - ⊙ Battery: 24V 12Ah/20Ah
 - ⊙ Parking brake: **electromagnetic brake**
 - ⊙ Frame material: Aluminium alloy
 - ⊙ Frame color: ○silver, ●blue, ●black
 - ⊙ Cushion: ● Blue mess
 - ⊙ Max speed: 6km/h
 - ⊙ Control: Jerry

											
34/38	1030	615	955	450	435	400	510	435	8	16	100

JRWD1802U



Electric Wheelchairs Series

- Features: Extra function based on JRWD1801
- Manual elevating footrest: adjustable angle 70°
 - Manual reclining backrest: adjustable angle 80°
 - Long driving distance, up to **30KM**.









- Parameters:
- ⊙ Driving range: >20km
 - ⊙ Motor: 250W *2Pcs (Jerry)
 - ⊙ Battery: 24V 12Ah/20Ah
 - ⊙ Parking brake: **manual brake**
 - ⊙ Frame material: steel with liquid painting
 - ⊙ Frame color: ○silver
 - ⊙ Cushion: ●black
 - ⊙ Max speed: 6km/h
 - ⊙ Control: Jerry

47/51	1125	635	970	450	430	390	530	370	10	18	100

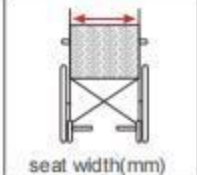
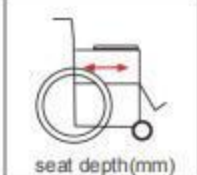
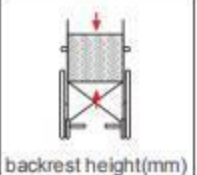
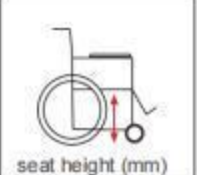
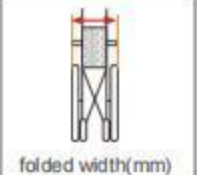

- Features: Extra function based on JRWD1801X
- Manual elevating footrest: adjustable angle 70°
 - Manual reclining backrest: adjustable angle 80°
 - Long driving distance, up to **30KM**.

- Parameters:
- ⊙ Driving range: >20km
 - ⊙ Motor: 250W *2Pcs (Jerry)
 - ⊙ Battery: 24V 12Ah/20Ah
 - ⊙ Parking brake: **manual & electromagnetic brake**
 - ⊙ Frame material: steel with liquid painting
 - ⊙ Frame color: ○ silver
 - ⊙ Cushion: ● black
 - ⊙ Max speed: 6km/h
 - ⊙ Control: Jerry

											
48/52	1120	635	970	450	430	400	535	425	10	18	100

JRWD1803U



Electric Wheelchairs Series

- Features: Extra function based on JRWD1801
- Electric elevating footrest: adjustable angle 70°
 - Electric reclining backrest: adjustable angle 45°
 - Long driving diastance, up to **30KM**.











- Parameters:
- ☉ Driving range: >20km
 - ☉ Motor: 250W *2Pcs (Jerry)
 - ☉ Battery: 24V 12Ah/20Ah
 - ☉ Parking brake: **manual brake**
 - ☉ Frame material: Steel with liquid painting
 - ☉ Frame color: ○ silver
 - ☉ Cushion: ● black
 - ☉ Max speed: 6km/h
 - ☉ Control: Jerry

50/53	1160	635	960	450	430	400	535	370	10	18	100

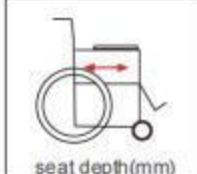

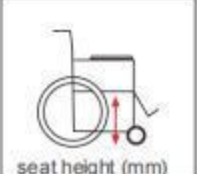
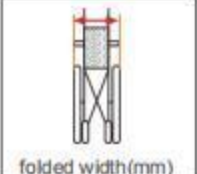
- Features: Extra function based on JRWD1801X
- Electric elevating footrest: adjustable angle 70°
 - Electric reclining backrest: adjustable angle 45°
 - Long driving diastance, up to **30KM**.

- Parameters:
- ⊙ Driving range: >20km
 - ⊙ Motor: 250W *2Pcs (Jerry)
 - ⊙ Battery: 24V 12Ah/20Ah
 - ⊙ Parking brake: **manual & electromagnetic brake**
 - ⊙ Frame material: Steel with liquid painting
 - ⊙ Frame color: ○ silver
 - ⊙ Cushion: ● black
 - ⊙ Max speed: 6km/h
 - ⊙ Control: Jerry

											
50/55	1155	635	960	450	430	400	535	425	10	18	100

JRWD2401



Electric Wheelchairs Series

- Features:
- Foldable
 - Operation mode: both manual mode and electric mode
 - Removable battery box for recharging
 - Flip-up armrest, adjustable and detachable footrest
 - Controller can be exchanged from right side to the left
 - Mag wheel











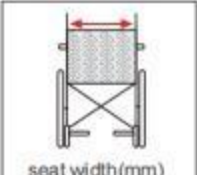

- Parameters:
- ⊙ Driving range: 15-20km
 - ⊙ Max speed: 6km/h
 - ⊙ Motor: 250W *2Pcs (Taiwan)
 - ⊙ Control: Jerry/PG/Dynamic
 - ⊙ Battery: 24V 20Ah/32Ah
 - ⊙ Parking brake: **electromagnetic brake**
 - ⊙ Frame material: aluminium alloy
 - ⊙ Frame color: ● Classic gray
 - ⊙ Cushion color: ● Blue mess

43	1100	685	950	450	435	400	510	430	8	24	100

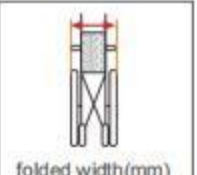

- Features:
- Foldable
 - Operation mode: both manual mode and electric mode
 - Removable battery box for recharging
 - Flip-up armrest, adjustable and detachable footrest
 - Controller can be exchanged from right side to the left
 - Long driving diastance, up to **35KM**.

- Parameters:
- ⊙ Driving range: >20km
 - ⊙ Motor: 250W *2Pcs (Jerry)
 - ⊙ Battery: 24V 12Ah/20Ah
 - ⊙ Parking brake: **manual brake**
 - ⊙ Frame material: aluminium alloy
 - ⊙ Frame color: ● silver, ● yellow, ● blue& black
 - ⊙ Cushion: ● Blue mess
 - ⊙ Max speed: 6km/h
 - ⊙ Control: Jerry

											
N.W. (kg)	overall length(mm)	overall width(mm)	overall height(mm)	seat width(mm)	seat depth(mm)	backrest height(mm)	seat height (mm)	folded width(mm)	front wheel(inch)	rear wheel(inch)	loading capacity(kg)
35/40	1030	675	955	450	435	400	510	470	8	22	100

JRWD2403



Electric Wheelchairs Series

- Features:
- Foldable
 - Operation mode: both manual mode and electric mode
 - Removable battery box for recharging
 - Flip-up armrest, adjustable and detachable footrest
 - Controller can be exchanged from right side to the left.









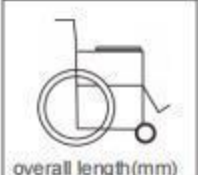

- Parameters:
- ⊙ Driving range: 15-20km
 - ⊙ Max speed: 6km/h
 - ⊙ Motor: 250W *2Pcs (Taiwan MTM)
 - ⊙ Control: Jerry/PG/Dynamic
 - ⊙ Battery: 24V 20Ah/32Ah
 - ⊙ Parking brake: **manual & electromagnetic brake**
 - ⊙ Frame material: aluminium alloy
 - ⊙ Frame color: ○silver, ●blue and black
 - ⊙ Cushion: ●blue mess

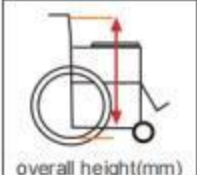
43	1080	660	945	450	435	400	510	410	8	22	100

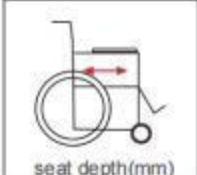
Manual wheelchair series

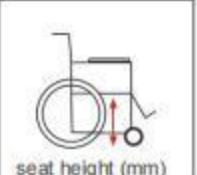

- ⊙ Frame material: aluminum alloy
- ⊙ Armrest: flip-up
- ⊙ Footrest: detachable
- ⊙ Brake: connecting (option: drum brake)
- ⊙ Frame color: blue and black, silver
- ⊙ Cushion color: blue mess
- ⊙ Option for backrest: strip with cover
- ⊙ Brake: hand brake & attendant brake

											
15	1010	630	915	450	435	395	460	325	6	16/22	100

JR202



Manual wheelchair series





- ◎ Frame material: Aluminum alloy
- ◎ Flip-up armrest, detachable footrest
- ◎ Cushion: Oxford cloth filled with sponge
- ◎ Frame color: Pink
- ◎ Cushion: Black

16	1030	630	965	450	435	405	505	340	8	24	100

Manual wheelchair series

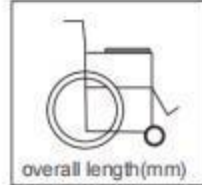

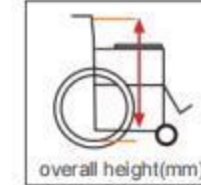
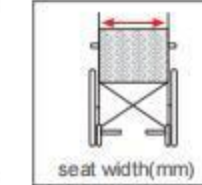
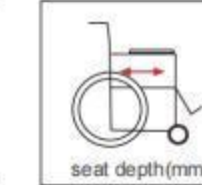
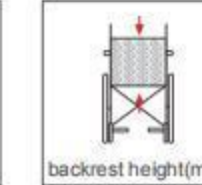
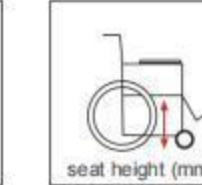
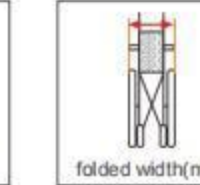
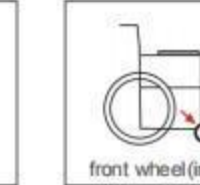
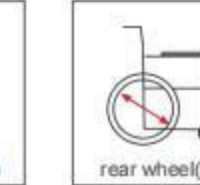
- ◎ Frame material: aluminum alloy
- ◎ Rear tire: quick release spoke wheel
- ◎ Hand rim: aluminum alloy
- ◎ Armrest: flip-up
- ◎ Footrest: detachable
- ◎ Brake: connecting (option: drum brake)
- ◎ Frame color: blue and black, silver
- ◎ Cushion color: blue mess
- ◎ Option for backrest: strip with cover

											
16	1030	630	965	450	435	405	505	340	8	24	100

LMW01-24801



Manual wheelchair series







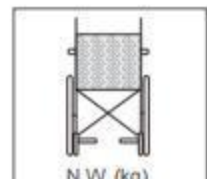
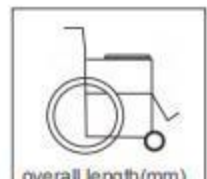

- ⊙ Frame material: steel with liquid painting
- ⊙ Fixed armrest, fixed footrest
- ⊙ Cushion: Oxford cloth filled with sponge
- ⊙ Frame color: Black
- ⊙ Cushion: Black

16	1150	640	875	470	405	370	490	295	8	24	100

Manual wheelchair series

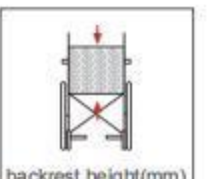
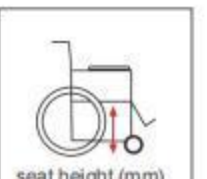
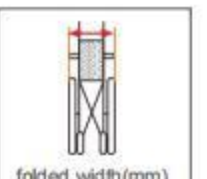

- ⊙ Frame material: steel with liquid painting
- ⊙ Flip-up armrest, detachable footrest
- ⊙ Cushion: Oxford cloth filled with sponge
- ⊙ Frame color: Blue
- ⊙ Cushion: Black

											
17	780	630	945	450	410	415	500	260	8	24	100

LMW02-16602



Manual wheelchair series

- ◎ Frame material: Aluminum alloy
- ◎ Ultralight manual wheelchair
- ◎ Cushion: Oxford cloth filled with sponge
- ◎ Frame color: silver
- ◎ Cushion color: orange/blue

13	950	665	880	440	410	375	435	285	6	16	100

Manual wheelchair series

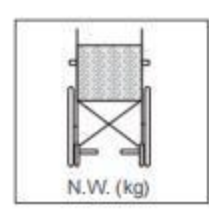
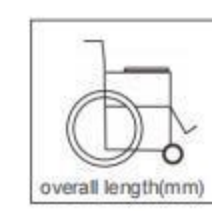
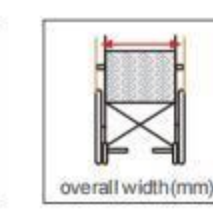
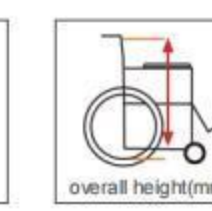
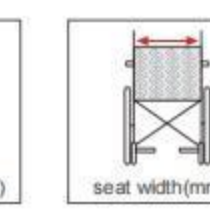
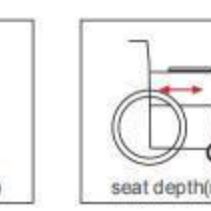
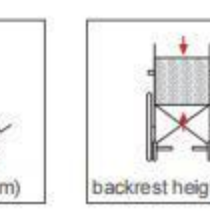
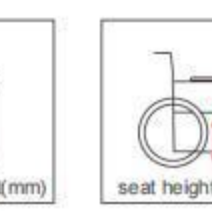
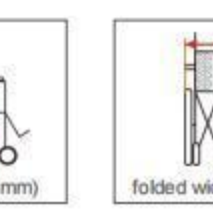
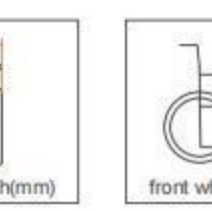
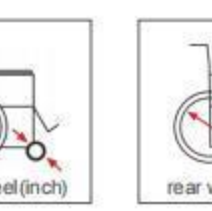
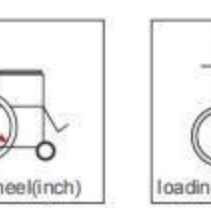

- ⊙ Frame material: Aluminum alloy
- ⊙ Ultralight manual wheelchair
- ⊙ Cushion: Oxford cloth filled with sponge
- ⊙ Frame color: silver
- ⊙ Cushion color: orange
- ⊙ Footrest: detachable
- ⊙ Backrest: foldable
- ⊙ Brake: hand brake & attendant brake, Drum brake

											
12	970	625	880	440	415	380	440	285	6	16	100

LMW02-22601



Manual wheelchair series



- ◎ Frame material: Aluminum alloy
- ◎ Ultralight manual wheelchair
- ◎ Cushion: Oxford cloth filled with sponge
- ◎ Frame color: silver
- ◎ Cushion color: orange/blue

12	950	660	860	440	410	375	435	285	6	22	100

Manual wheelchair series

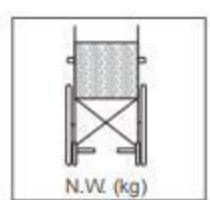
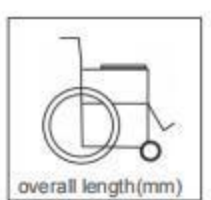
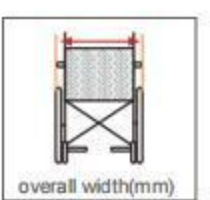
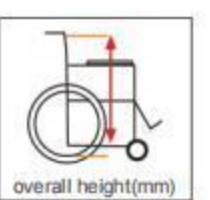
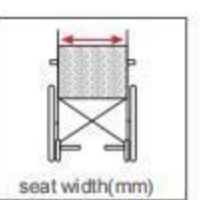
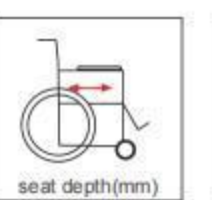
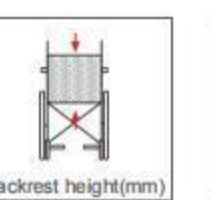
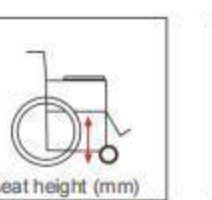
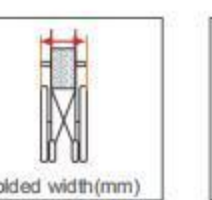
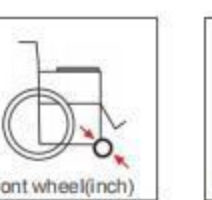
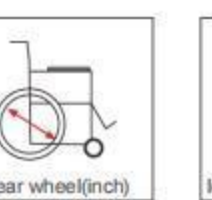

- ⊙ Frame material: Aluminum alloy
- ⊙ Ultralight manual wheelchair
- ⊙ Cushion: Oxford cloth filled with sponge
- ⊙ Frame color: silver
- ⊙ Cushion color: orange/blue

											
13	950	665	880	440	410	375	435	285	6	22	100

LMW02-22603



Manual wheelchair series







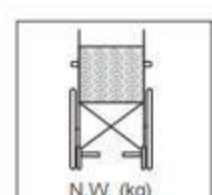
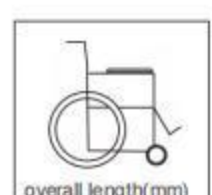

- ◎ Frame material: Aluminum alloy
- ◎ Ultralight manual wheelchair
- ◎ Cushion: Oxford cloth filled with sponge
- ◎ Frame color: silver
- ◎ Cushion color: orange
- ◎ Footrest: detachable
- ◎ Backrest: foldable
- ◎ Brake: hand brake & attendant brake, Drum brake

12	970	625	880	440	415	380	440	285	6	22	100

Manual wheelchair series

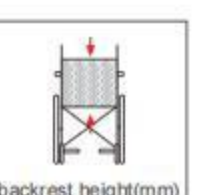
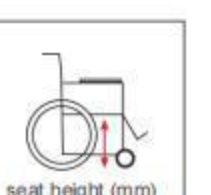
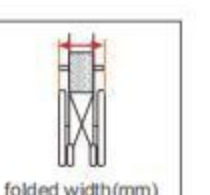

- ◎ Frame material: steel with liquid painting
- ◎ Footrest: Detachable
- ◎ Backrest: Foldable, Manual reclining
- ◎ Brake: Hand brake, attendant brake

											
26	1250	655	1305	450	480	470	535	300	8	24	100

JRWB802



Mobility scooter series

- Features:
- Foldable sponge cushion
 - Adjustable angle of tiller
 - Flip-up armrest, adjustable armrest width and seat height
 - Rotatable seat base for convenient up and down the scooter

- Parameters:
- ⊙ Driving range: <20km
 - ⊙ Motor: 250W
 - ⊙ Battery: 24V 12Ah
 - ⊙ Parking brake: **electromagnetic brake**
 - ⊙ Frame color: ● red
 - ⊙ Cushion color: ● black
 - ⊙ Max speed: 6km/h
 - ⊙ Control: Dynamic

53	1170	520	1010	420	390	380	565	N/A	9	9	100



YWJ.001

Parameters:

Product Name: Power Patient Transfer Lift

Battery Capacity: N/A

Input Voltage: 100-240V AC

Lifting Range: 752-1752±20mm

Lifting Motor: 24V 8000N

Lifting Speed: 3-9mm/s

Controller: Matched with Haojiang Battery

Noise: < 65dB

Overall Length: 1230±20mm

Overall Width: 630±20mm

Leg spread width: 920±20mm

Main Support Angle: 74°

Push Rod Stroke: 300mm

Front Wheel: 3 Inch

Rear Wheel: 4 Inch

Maximum User Weight: 150Kg

YWJ.002

Parameters:

Product Name: Power Patient Transfer Lift

Battery Capacity: Lead-acid battery

Input Voltage: 100-240V AC

Lifting Range: 752-1752±20mm

Lifting Motor: 24V 8000N

Lifting Speed: 3-9mm/s

Controller: Matched with Haojiang Battery

Noise: < 65dB

Overall Length: 1230±20mm

Overall Width: 630±20mm

Leg spread width: 920±20mm

Main Support Angle: 74°

Push Rod Stroke: 300mm

Front Wheel: 3 Inch

Rear Wheel: 4 Inch

Maximum User Weight: 150Kg



Controller



OM CONTROLLER



OM MULTI-FUNCTIONAL
CONTROLLER



PG CONTROLLER



MULTI-FUNCTIONAL
DYNAMIC CONTROLLER



DYNAMIC CONTROLLER



LED CONTROLLER

Jerry Spare Parts

Motor



DOMESTIC MOTOR



“X” MOTOR



“H” MOTOR



MTM MOTOR



Jerry ♥ Just for a better life!



Jerry Medical Instrument (Shanghai) Co., Ltd.
Add: Room 116,Block A, Building 1,No.288 Jiachang Road,
MaluTown, Jiading District, Shanghai, China
Tel: 0086 (0)21 59517538
Fax: 0086 (0)21 59517529
Email: jerry@jerrymedical.com
Website: www.jerrymedical.com